

NOUVELLE COLLECTION

NUOVA COLLEZIONE

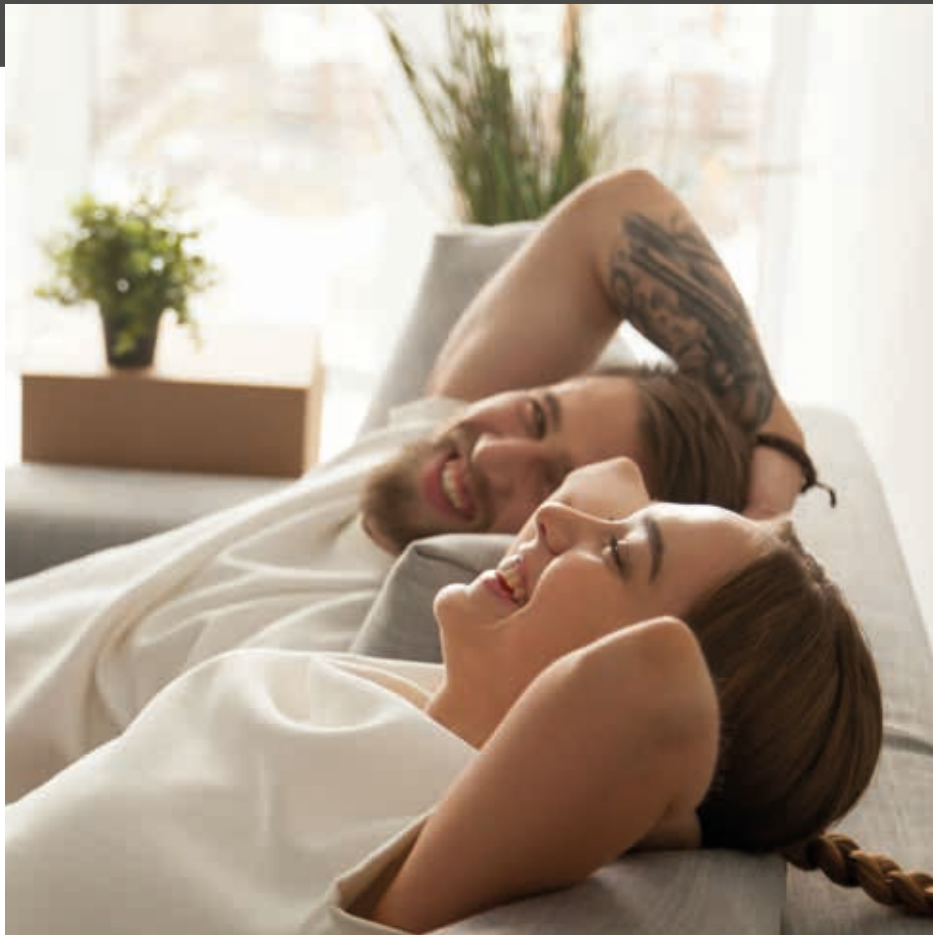

NEW COLLECTION

CATALOGUE

CATALOGO / CATALOG

BENVENUTI

Nous sommes heureux de vous présenter notre nouvelle collection: ce sont tous des produits artisanaux de fabrication italienne, donc exclusivement et rigoureusement Made in Italy.

Siamo lieti di presentarvi la nostra nuova collezione: prodotti artigianali completamente Made in Italy.

WELCOME

We are pleased to present to you our new collection, handmade products totally Made in Italy.

BIENVENUE

MondoSofa

INDEX

INDICE / INDEX

- _6 CANAPES - LITS /**
DIVANI-LETTO / SOFA BEDS

- _56 MATELAS**
MATERASSI / MATTRESSES

- _60 CANAPES FIXES**
DIVANI FISSI / FIXED SOFAS

- _72 MEUBLES /**
MOBILI / FURNITURE

CANAPES-LITS

DIVANI-LETTO / SOFA BEDS

- _6** BL/000
- _8** BL/001 - BL/018 - BL/020
- _10** BL/009 - BL/010
- _12** BL/012
- _14** BL/013
- _16** BL/016
- _18** CIPRO A - CIPRO B
- _20** EUREKA
- _22** JANIS
- _24** KIRA
- _26** MIKA
- _28** MYKONOS A - MYKONOS B
- _30** PANAMA
- _32** PAOLA
- _34** PATHOS
- _36** PATRASSO
- _38** PATRY
- _40** PIREO
- _42** ROMINA
- _44** SANDRA
- _46** SANTIAGO
- _48** SELENE
- _50** SKY
- _52** STRIKE
- _54** TOM

MATELAS

MATERASSI / MATTRESSES

- _56 MATELAS / MATERASSI /**
MATTRESSES

CANAPES FIXES

DIVANI FISSI / FIXED SOFAS

- _60** GLAMOUR
- _61** LOFT
- _62** LORY
- _63** MERCURE
- _64** MIMOSA
- _65** NEW CLARA
- _66** NEW VOGUE
- _67** PONZA
- _68** SPACE
- _69** SUN
- _70** VIVIANE

MEUBLES

MOBILI / FURNITURE

- _72 ARMOIRES LITS**
ESCAMOTABLES /
ARMADI LETTO / WALL BEDS

- _76 SOMMIERS /**
SOMMIER / BOX-SPRINGS

- _78 TETES DE LIT / TESTATE**
LETTO / HEADBOARDS

MODELE BL/000

STRUCTURE: bois et dérivés

REMOBLEMENT: polyuréthane expansé à densités diversifiées (densité assise: 30 kg/m³, densité dossier: 18 kg/m³)

REVÊTEMENT: tissu ou cuir

SYSTÈME-LIT: sommier électrosoudé double pliage avec matelas H14/18/20 cm en tissu jacquard/stretch

PIEDS: plastique ou bois

STRUTTURA: legno e derivati

IMBOTTITURE: poliuretano espanso a densità diversificate (densità seduta: 30 kg/m³, densità schienale: 18 kg/m³)

RIVESTIMENTO: tessuto o pelle

SISTEMA-LETTO: rete elettrosaldata a doppia piega con materasso H14/18 cm rivestito in tessuto jacquard/stretch

PIEDI: plastica o legno

STRUCTURE: wood and various by-products

FILLING: expanded polyurethane foam with different densities (seat density: 30 kg/m³, back density: 18 kg/m³)

COVERING: fabric or leather

BED SYSTEM: electro-welded 2 folds bed mechanism with mattress H14/18 cm covered with jacquard/stretch fabric

FEET: plastic or wood

Canapé-lit disponible avec plusieurs matelas

Divano-letto disponibile con diversi materassi / Sofabed available with different mattresses

BL/000

Matelas
Materasso / Mattress
H14 cm

Assise
Seduta / Seat
H48 cm



Coffre / Contenitore /
Storage

LIT / Letto / Bed

Canapés / Divani / Sofas

2P

3P

3P Maxi

Matelas / Materasso / Mattress

120 x 195

140 x 195

160 x 195

Encombrement maximal avec lit ouvert /
Ingombro massimo aperto /
Maximum size with open bed

155 x 210

175 x 210

195 x 210

Dimensions / Dimensioni / Dimensions:

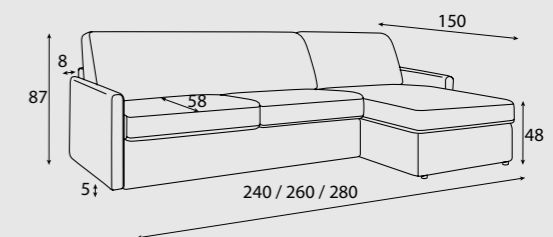
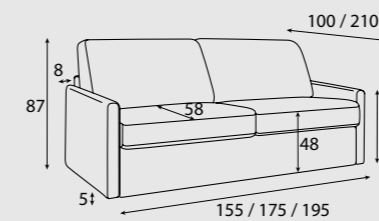

Toutes les dimensions ±3% / Tutte le dimensioni ±3% / All dimensions ±3%
Dimensions en cm / Misure espresse in cm / Dimensions in cm

MODELE BL/001 - BL/018 - BL/020

STRUCTURE: bois et dérivés

REMOBORAGE: polyuréthane expansé à densités diversifiées (densité assise: 30 kg/m³, densité dossier: 18 kg/m³)

REVÊTEMENT: tissu ou cuir

SYSTÈME-LIT: sommier électrosoudé double pliage avec matelas H14/18/20 cm en tissu jacquard/stretch

PIEDS: plastique ou bois

STRUTTURA: legno e derivati

IMBOTTITURE: poliuretano espanso a densità diversificate (densità seduta: 30 kg/m³, densità schienale: 18 kg/m³)

RIVESTIMENTO: tessuto o pelle

SISTEMA-LETTO: rete elettrosaldata a doppia piega con materasso H14/18 cm rivestito in tessuto jacquard/stretch

PIEDI: plastica o legno

STRUCTURE: wood and various by-products

FILLING: expanded polyurethane foam with different densities (seat density: 30 kg/m³, back density: 18 kg/m³)

COVERING: fabric or leather

BED SYSTEM: electro-welded 2 folds bed mechanism with mattress H14/18 cm covered with jacquard/stretch fabric

FEET: plastic or wood

Canapé-lit disponible avec plusieurs matelas

Divano-letto disponibile con diversi materassi / Sofabed available with different mattresses

BL/001

Matelas
Materasso / Mattress
H14 cm

Assise
Seduta / Seat
H48 cm

BL/018

Matelas
Materasso / Mattress
H18 cm

Assise
Seduta / Seat
H52 cm

BL/020

Matelas
Materasso / Mattress
H20 cm

Assise
Seduta / Seat
H52 cm



LIT / Letto / Bed

Coffre / Contenitore / Storage



Canapés / Divani / Sofas

2P

3P

3P Maxi

Matelas / Materasso / Mattress

120 x 195

140 x 195

160 x 195

Encombrement maximal avec lit ouvert /
Ingombro massimo aperto /
Maximum size with open bed

170 x 210

190 x 210

210 x 210

Dimensions / Dimensioni / Dimensions:

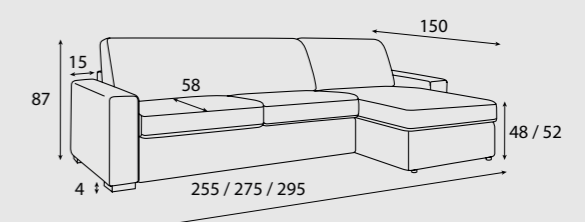
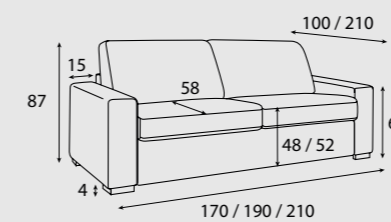

Toutes les dimensions ±3% / Tutte le dimensioni ±3% / All dimensions ±3%
Dimensions en cm / Misure espresse in cm / Dimensions in cm

MODELE BL/009 - BL/010 - BL/011

STRUCTURE: bois et dérivés

REMOBILISATION: polyuréthane expansé à densités diversifiées (densité assise: 30 kg/m³, densité dossier: 18 kg/m³)

REVÊTEMENT: tissu ou cuir

SYSTÈME-LIT: sommier électrosoudé double pliage avec matelas H14/18/20 cm en tissu jacquard/stretch

PIEDS: plastique ou bois

STRUTTURA: legno e derivati

IMBOTTITURE: poliuretano espanso a densità diversificate (densità seduta: 30 kg/m³, densità schienale: 18 kg/m³)

RIVESTIMENTO: tessuto o pelle

SISTEMA-LETTO: rete elettrosaldata a doppia piega con materasso H14/18 cm rivestito in tessuto jacquard/stretch

PIEDI: plastica o legno

STRUCTURE: wood and various by-products

FILLING: expanded polyurethane foam with different densities (seat density: 30 kg/m³, back density: 18 kg/m³)

COVERING: fabric or leather

BED SYSTEM: electro-welded 2 folds bed mechanism with mattress H14/18 cm covered with jacquard/stretch fabric

FEET: plastic or wood

Canapé-lit disponible avec plusieurs matelas

Divano-letto disponibile con diversi materassi / Sofabed available with different mattresses

BL/009

Matelas
Materasso / Mattress
H14 cm

Assise
Seduta / Seat
H48 cm

BL/010

Matelas
Materasso / Mattress
H18 cm

Assise
Seduta / Seat
H52 cm

BL/011

Matelas
Materasso / Mattress
H20 cm

Assise
Seduta / Seat
H52 cm



Canapés / Divani / Sofas

2P

3P

3P Maxi

Matelas / Materasso / Mattress

120 x 195

140 x 195

160 x 195

Encombrement maximal avec lit ouvert /
Ingombro massimo aperto /
Maximum size with open bed

155 x 210

175 x 210

195 x 210

Dimensions / Dimensioni / Dimensions:

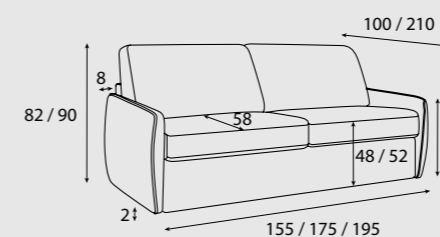

Toutes les dimensions ±3% / Tutte le dimensioni ±3% / All dimensions ±3%
Dimensions en cm / Misure espresse in cm / Dimensions in cm

MODELE BL/012

STRUCTURE: bois et dérivés
 REMBOURRAGE: polyuréthane expansé à densités diversifiées (densité assise: 30 kg/m3, densité dossier: 18 kg/m3)
 REVÊTEMENT: tissu ou cuir
 SYSTÈME-LIT: sommier électrosoudé double pliage avec matelas H14 cm en tissu jacquard/stretch
 PIEDS: plastique ou bois

STRUTTURA: legno e derivati
 IMBOTTITURE: poliuretano espanso a densità diversificate (densità seduta: 30 kg/m3, densità schienale: 18 kg/m3)
 RIVESTIMENTO: tessuto o pelle
 SISTEMA-LETTO: rete elettrosaldata a doppia piega con materasso H14 cm rivestito in tessuto jacquard/stretch
 PIEDI: plastica o legno

STRUCTURE: wood and various by-products
 FILLING: expanded polyurethane foam with different densities (seat density: 30 kg/m3, back density: 18 kg/m3)
 COVERING: fabric or leather
 BED SYSTEM: electro-welded 2 folds bed mechanism with mattress H14 cm covered with jacquard/stretch fabric
 FEET: plastic or wood

Canapé-lit disponible avec plusieurs matelas
 Divano-letto disponibile con diversi materassi / Sofabed available with different mattresses

BL/012

Matelas
 Materasso / Mattress
H14 cm

Assise
 Seduta / Seat
H46 cm



LIT / Letto / Bed

Coffre / Contenitore / Storage



Canapés / Divani / Sofas

2P

3P

3P Maxi

Matelas / Materasso / Mattress

120 x 195

140 x 195

160 x 195

Encombrement maximal avec lit ouvert /
 Ingombro massimo aperto /
 Maximum size with open bed

170 x 210

190 x 210

210 x 210

Dimensions / Dimensioni / Dimensions:

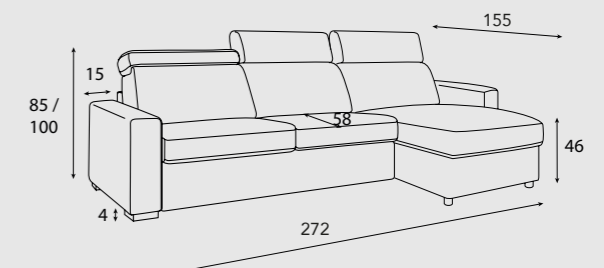
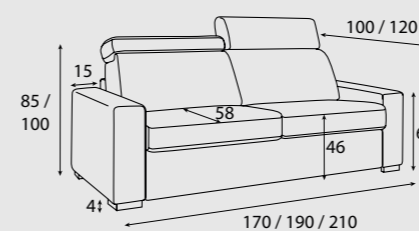

Toutes les dimensions ±3% / Tutte le dimensioni ±3% / All dimensions ±3%
 Dimensions en cm / Misure espresse in cm / Dimensions in cm

MODELE BL/013

STRUCTURE: bois et dérivés

REMOBORAGE: polyuréthane expansé à densités diversifiées (densité assise: 30 kg/m³, densité dossier: 18 kg/m³)

REVÊTEMENT: tissu ou cuir

SYSTÈME-LIT: sommier électrosoudé double pliage avec matelas H14 cm en tissu jacquard/stretch

PIEDS: plastique ou bois

STRUTTURA: legno e derivati

IMBOTTITURE: poliuretano espanso a densità diversificate (densità seduta: 30 kg/m³, densità schienale: 18 kg/m³)

RIVESTIMENTO: tessuto o pelle

SISTEMA-LETTO: rete elettrosaldata a doppia piega con materasso H14 cm rivestito in tessuto jacquard/stretch

PIEDI: plastica o legno

STRUCTURE: wood and various by-products

FILLING: expanded polyurethane foam with different densities (seat density: 30 kg/m³, back density: 18 kg/m³)

COVERING: fabric or leather

BED SYSTEM: electro-welded 2 folds bed mechanism with mattress H14 cm covered with jacquard/stretch fabric

FEET: plastic or wood

Canapé-lit disponible avec plusieurs matelas

Divano-letto disponibile con diversi materassi / Sofabed available with different mattresses

BL/013

Matelas
Materasso / Mattress
H14 cm

Assise
Seduta / Seat
H45 cm



Option poche /
Tasca opzionale /
Pocket option



Canapés / Divani / Sofas

2P

3P

3P Maxi

Matelas / Materasso / Mattress

120 x 195

140 x 195

160 x 195

Encombrement maximal avec lit ouvert /
Ingombro massimo aperto /
Maximum size with open bed

172 x 210

192 x 210

212 x 210

Dimensions / Dimensioni / Dimensions:

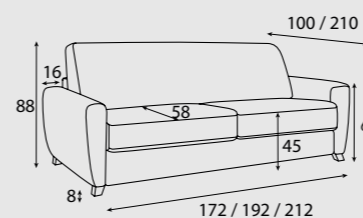

Option poche / Tasca opzionale / Pocket option



Toutes les dimensions ±3% / Tutte le dimensioni ±3% / All dimensions ±3%
Dimensions en cm / Misure espresse in cm / Dimensions in cm

MODELE BL/016

STRUCTURE: bois et dérivés

REMBOURRAGE: polyuréthane expansé à densités diversifiées (densité assise: 30 kg/m³, densité dossier: 18 kg/m³)

REVÊTEMENT: tissu ou cuir

SYSTÈME-LIT: sommier électrosoudé double pliage avec matelas H14 cm en tissu jacquard/stretch

PIEDS: plastique ou bois

STRUTTURA: legno e derivati

IMBOTTITURE: poliuretano espanso a densità diversificate (densità seduta: 30 kg/m³, densità schienale: 18 kg/m³)

RIVESTIMENTO: tessuto o pelle

SISTEMA-LETTO: rete elettrosaldata a doppia piega con materasso H14 cm rivestito in tessuto jacquard/stretch

PIEDI: plastica o legno

STRUCTURE: wood and various by-products

FILLING: expanded polyurethane foam with different densities (seat density: 30 kg/m³, back density: 18 kg/m³)

COVERING: fabric or leather

BED SYSTEM: electro-welded 2 folds bed mechanism with mattress H14 cm covered with jacquard/stretch fabric

FEET: plastic or wood

Canapé-lit disponible avec plusieurs matelas

Divano-letto disponibile con diversi materassi / Sofabed available with different mattresses

BL/016

Matelas
Materasso / Mattress
H14 cm

Assise
Seduta / Seat
H48 cm



Canapés / Divani / Sofas

2P

3P

3P Maxi

Matelas / Materasso / Mattress

120 x 195

140 x 195

160 x 195

Encombrement maximal avec lit ouvert /
Ingombro massimo aperto /
Maximum size with open bed

148 x 210

168 x 210

188 x 210

Dimensions / Dimensioni / Dimensions:

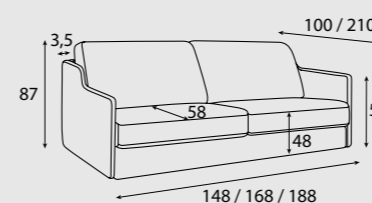

Toutes les dimensions ±3% / Tutte le dimensioni ±3% / All dimensions ±3%
Dimensions en cm / Misure espresse in cm / Dimensions in cm

MODELE CIPRO A - CIPRO B

STRUCTURE: bois et dérivés

REMOBOURRAGE: polyuréthane expansé à densités diversifiées (densité assise: 30 kg/m3, densité dossier: 18 kg/m3)

REVÊTEMENT: tissu ou cuir

SYSTÈME-LIT: sommier électrosoudé double pliage avec matelas H14 cm en tissu jacquard/stretch

PIEDS: plastique ou bois

STRUTTURA: legno e derivati

IMBOTTITURE: poliuretano espanso a densità diversificate (densità seduta: 30 kg/m3, densità schienale: 18 kg/m3)

RIVESTIMENTO: tessuto o pelle

SISTEMA-LETTO: rete elettrosaldata a doppia piega con materasso H14 cm rivestito in tessuto jacquard/stretch

PIEDI: plastica o legno

STRUCTURE: wood and various by-products

FILLING: expanded polyurethane foam with different densities (seat density: 30 kg/m3, back density: 18 kg/m3)

COVERING: fabric or leather

BED SYSTEM: electro-welded 2 folds bed mechanism with mattress H14 cm covered with jacquard/stretch fabric

FEET: plastic or wood

Canapé-lit disponible avec plusieurs matelas

Divano-letto disponibile con diversi materassi / Sofabed available with different mattresses

CIPRO A - CIPRO B

Matelas
Materasso / Mattress
H14 cm

Assise
Seduta / Seat
H45 cm



CIPRO A



CIPRO B



Canapés / Divani / Sofas

2P

3P

3P Maxi

Matelas / Materasso / Mattress

120 x 195

140 x 195

160 x 195

Encombrement maximal avec lit ouvert /
Ingombro massimo aperto /
Maximum size with open bed

165 x 210

185 x 210

205 x 210

Dimensions / Dimensioni / Dimensions:

CIPRO A

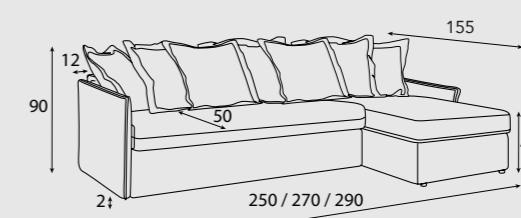
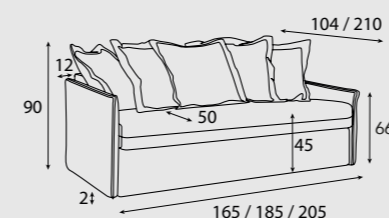

CIPRO B

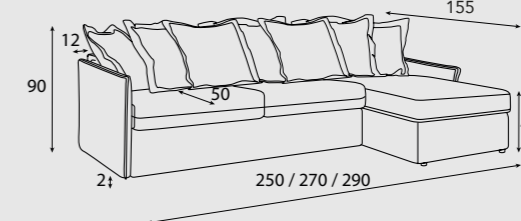
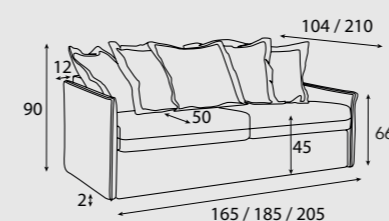

Toutes les dimensions ±3% / Tutte le dimensioni ±3% / All dimensions ±3%
Dimensions en cm / Misure espresse in cm / Dimensions in cm

MODELE EUREKA

STRUCTURE: bois et dérivés
 REMBOURRAGE: polyuréthane expansé à densités diversifiées (densité assise: 30 kg/m³, densité dossier: 18 kg/m³)
 REVÊTEMENT: tissu ou cuir
 SYSTÈME-LIT: sommier électrosoudé double pliage avec matelas H22 cm en tissu jacquard/stretch
 PIEDS: plastique ou bois

STRUTTURA: legno e derivati
 IMBOTTITURE: poliuretano espanso a densità diversificate (densità seduta: 30 kg/m³, densità schienale: 18 kg/m³)
 RIVESTIMENTO: tessuto o pelle
 SISTEMA-LETTO: rete elettrosaldata a doppia piega con materasso H22 cm rivestito in tessuto jacquard/stretch
 PIEDI: plastica o legno

STRUCTURE: wood and various by-products
 FILLING: expanded polyurethane foam with different densities (seat density: 30 kg/m³, back density: 18 kg/m³)
 COVERING: fabric or leather
 BED SYSTEM: electro-welded 2 folds bed mechanism with mattress H22 cm covered with jacquard/stretch fabric
 FEET: plastic or wood

Canapé-lit disponible avec plusieurs matelas
 Divano-letto disponibile con diversi materassi / Sofabed available with different mattresses

EUREKA

Matelas
 Materasso / Mattress
H22 cm

Assise
 Seduta / Seat
H51 cm



LIT / Letto / Bed

Coffre / Contenitore / Storage



Canapés / Divani / Sofas

2P

3P

3P Maxi

Matelas / Materasso / Mattress

120 x 195

140 x 195

160 x 195

Encombrement maximal avec lit ouvert /
 Ingombro massimo aperto /
 Maximum size with open bed

180 x 210

200 x 210

220 x 210

Dimensions / Dimensioni / Dimensions:

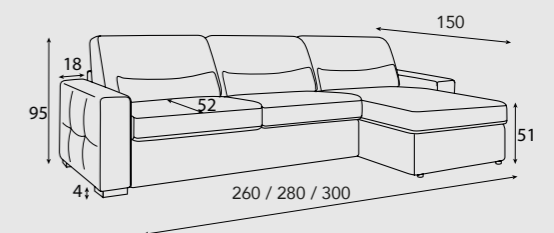
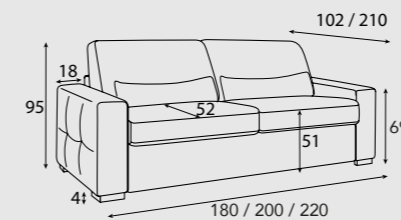

Toutes les dimensions ±3% / Tutte le dimensioni ±3% / All dimensions ±3%
 Dimensions en cm / Misure espresse in cm / Dimensions in cm

MODELE JANIS

STRUCTURE: bois et dérivés
 REMBOURRAGE: polyuréthane expansé à densités diversifiées (densité assise: 30 kg/m³, densité dossier: 18 kg/m³)
 REVÊTEMENT: tissu ou cuir
 SYSTÈME-LIT: sommier électrosoudé double pliage avec matelas H14 cm en tissu jacquard/stretch
 PIEDS: plastique ou bois

STRUTTURA: legno e derivati
 IMBOTTITURE: poliuretano espanso a densità diversificate (densità seduta: 30 kg/m³, densità schienale: 18 kg/m³)
 RIVESTIMENTO: tessuto o pelle
 SISTEMA-LETTO: rete elettrosaldata a doppia piega con materasso H14 cm rivestito in tessuto jacquard/stretch
 PIEDI: plastica o legno

STRUCTURE: wood and various by-products
 FILLING: expanded polyurethane foam with different densities (seat density: 30 kg/m³, back density: 18 kg/m³)
 COVERING: fabric or leather
 BED SYSTEM: electro-welded 2 folds bed mechanism with mattress H14 cm covered with jacquard/stretch fabric
 FEET: plastic or wood

Canapé-lit disponible avec plusieurs matelas
 Divano-letto disponibile con diversi materassi / Sofabed available with different mattresses

JANIS

Matelas
 Materasso / Mattress
H14 cm

Assise
 Seduta / Seat
H48 cm



Canapés / Divani / Sofas

2P

3P

3P Maxi

Matelas / Materasso / Mattress

120 x 195

140 x 195

160 x 195

Encombrement maximal avec lit ouvert /
 Ingombro massimo aperto /
 Maximum size with open bed

166 x 210

186 x 210

206 x 210

Dimensions / Dimensioni / Dimensions:

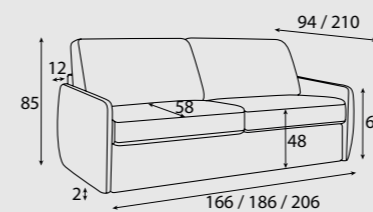

Toutes les dimensions ±3% / Tutte le dimensioni ±3% / All dimensions ±3%
 Dimensions en cm / Misure espresse in cm / Dimensions in cm

MODELE KIRA

STRUCTURE: bois et dérivés
 REMBOURRAGE: polyuréthane expansé à densités diversifiées (densité assise: 30 kg/m³, densité dossier: 18 kg/m³)
 REVÊTEMENT: tissu ou cuir
 SYSTÈME-LIT: sommier électrosoudé double pliage avec matelas H14 cm en tissu jacquard/stretch
 PIEDS: plastique ou bois

STRUTTURA: legno e derivati
 IMBOTTITURE: poliuretano espanso a densità diversificate (densità seduta: 30 kg/m³, densità schienale: 18 kg/m³)
 RIVESTIMENTO: tessuto o pelle
 SISTEMA-LETTO: rete elettrosaldata a doppia piega con materasso H14 cm rivestito in tessuto jacquard/stretch
 PIEDI: plastica o legno

STRUCTURE: wood and various by-products
 FILLING: expanded polyurethane foam with different densities (seat density: 30 kg/m³, back density: 18 kg/m³)
 COVERING: fabric or leather
 BED SYSTEM: electro-welded 2 folds bed mechanism with mattress H14 cm covered with jacquard/stretch fabric
 FEET: plastic or wood

Canapé-lit disponible avec plusieurs matelas
 Divano-letto disponibile con diversi materassi / Sofabed available with different mattresses

KIRA
 Matelas
 Materasso / Mattress
H14 cm
 Assise
 Seduta / Seat
H47 cm



Canapés / Divani / Sofas	2P	3P	3P Maxi
Matelas / Materasso / Mattress	120 x 195	140 x 195	160 x 195
Encombrement maximal avec lit ouvert / Ingombro massimo aperto / Maximum size with open bed	180 x 210	200 x 210	220 x 210

Dimensions / Dimensioni / Dimensions:

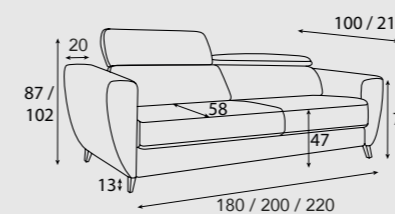

Toutes les dimensions ±3% / Tutte le dimensioni ±3% / All dimensions ±3%
 Dimensions en cm / Misure espresse in cm / Dimensions in cm

MODELE MIKA

STRUCTURE: bois et dérivés

REMBOURRAGE: polyuréthane expansé à densités diversifiées (densité assise: 30 kg/m³, densité dossier: 18 kg/m³)

REVÊTEMENT: tissu ou cuir

SYSTÈME-LIT: sommier électrosoudé double pliage avec matelas H14 cm en tissu jacquard/stretch

PIEDS: plastique ou bois

STRUTTURA: legno e derivati

IMBOTTITURE: poliuretano espanso a densità diversificate (densità seduta: 30 kg/m³, densità schienale: 18 kg/m³)

RIVESTIMENTO: tessuto o pelle

SISTEMA-LETTO: rete elettrosaldata a doppia piega con materasso H14 cm rivestito in tessuto jacquard/stretch

PIEDI: plastica o legno

STRUCTURE: wood and various by-products

FILLING: expanded polyurethane foam with different densities (seat density: 30 kg/m³, back density: 18 kg/m³)

COVERING: fabric or leather

BED SYSTEM: electro-welded 2 folds bed mechanism with mattress H14 cm covered with jacquard/stretch fabric

FEET: plastic or wood

Canapé-lit disponible avec plusieurs matelas

Divano-letto disponibile con diversi materassi / Sofabed available with different mattresses

MIKA

Matelas
Materasso / Mattress

H14 cm

Assise
Seduta / Seat

H45 cm



Canapés / Divani / Sofas

2P

3P

3P Maxi

Matelas / Materasso / Mattress

120 x 195

140 x 195

160 x 195

Encombrement maximal avec lit ouvert /
Ingombro massimo aperto /
Maximum size with open bed

165 x 210

185 x 210

205 x 210

Dimensions / Dimensioni / Dimensions:

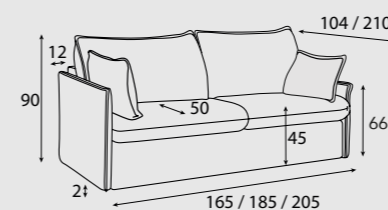

Toutes les dimensions ±3% / Tutte le dimensioni ±3% / All dimensions ±3%
Dimensions en cm / Misure espresse in cm / Dimensions in cm

MODELE MYKONOS A - MYKONOS B

STRUCTURE: bois et dérivés

REMOBOURRAGE: polyuréthane expansé à densités diversifiées (densité assise: 30 kg/m3, densité dossier: 18 kg/m3)

REVÊTEMENT: tissu ou cuir

SYSTÈME-LIT: sommier électrosoudé double pliage avec matelas H14 cm en tissu jacquard/stretch

PIEDS: plastique ou bois

STRUTTURA: legno e derivati

IMBOTTITURE: poliuretano espanso a densità diversificate (densità seduta: 30 kg/m3, densità schienale: 18 kg/m3)

RIVESTIMENTO: tessuto o pelle

SISTEMA-LETTO: rete elettrosaldata a doppia piega con materasso H14 cm rivestito in tessuto jacquard/stretch

PIEDI: plastica o legno

STRUCTURE: wood and various by-products

FILLING: expanded polyurethane foam with different densities (seat density: 30 kg/m3, back density: 18 kg/m3)

COVERING: fabric or leather

BED SYSTEM: electro-welded 2 folds bed mechanism with mattress H14 cm covered with jacquard/stretch fabric

FEET: plastic or wood

Canapé-lit disponible avec plusieurs matelas

Divano-letto disponibile con diversi materassi / Sofabed available with different mattresses

MYKONOS A - MYKONOS B

Matelas
Materasso / Mattress
H14 cm

Assise
Seduta / Seat
H45 cm

MYKONOS A



MYKONOS B



Canapés / Divani / Sofas

2P

3P

3P Maxi

Matelas / Materasso / Mattress

120 x 195

140 x 195

160 x 195

Encombrement maximal avec lit ouvert /
Ingombro massimo aperto /
Maximum size with open bed

165 x 210

185 x 210

205 x 210

Dimensions / Dimensioni / Dimensions:

MYKONOS A

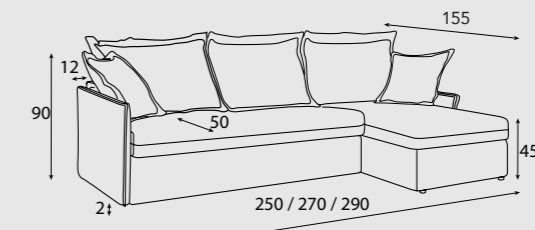
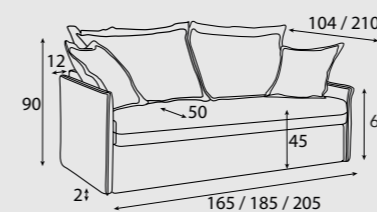

MYKONOS B

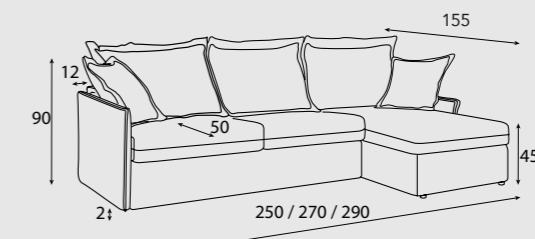
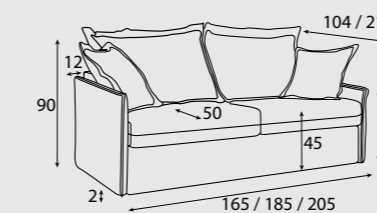

Toutes les dimensions ±3% / Tutte le dimensioni ±3% / All dimensions ±3%
Dimensions en cm / Misure espresse in cm / Dimensions in cm

MODELE PANAMA

STRUCTURE: bois et dérivés

REMBOURRAGE: polyuréthane expansé à densités diversifiées (densité assise: 30 kg/m³, densité dossier: 18 kg/m³)

REVÊTEMENT: tissu ou cuir

SYSTÈME-LIT: sommier électrosoudé double pliage avec matelas H14 cm en tissu jacquard/stretch

PIEDS: plastique ou bois

STRUTTURA: legno e derivati

IMBOTTITURE: poliuretano espanso a densità diversificate (densità seduta: 30 kg/m³, densità schienale: 18 kg/m³)

RIVESTIMENTO: tessuto o pelle

SISTEMA-LETTO: rete elettrosaldata a doppia piega con materasso H14 cm rivestito in tessuto jacquard/stretch

PIEDI: plastica o legno

STRUCTURE: wood and various by-products

FILLING: expanded polyurethane foam with different densities (seat density: 30 kg/m³, back density: 18 kg/m³)

COVERING: fabric or leather

BED SYSTEM: electro-welded 2 folds bed mechanism with mattress H14 cm covered with jacquard/stretch fabric

FEET: plastic or wood

Canapé-lit disponible avec plusieurs matelas

Divano-letto disponibile con diversi materassi / Sofabed available with different mattresses

PANAMA

Matelas
Materasso / Mattress
H14 cm

Assise
Seduta / Seat
H45 cm



Canapés / Divani / Sofas

2P

3P

3P Maxi

Matelas / Materasso / Mattress

120 x 195

140 x 195

160 x 195

Encombrement maximal avec lit ouvert /
Ingombro massimo aperto /
Maximum size with open bed

182 x 210

202 x 210

222 x 210

Dimensions / Dimensioni / Dimensions:

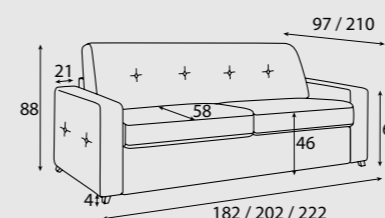

Toutes les dimensions ±3% / Tutte le dimensioni ±3% / All dimensions ±3%
Dimensions en cm / Misure espresse in cm / Dimensions in cm

MODELE PAOLA

STRUCTURE: bois et dérivés
 REMBOURRAGE: polyuréthane expansé à densités diversifiées (densité assise: 30 kg/m³, densité dossier: 18 kg/m³)
 REVÊTEMENT: tissu ou cuir
 SYSTÈME-LIT: sommier électrosoudé double pliage avec matelas H14 cm en tissu jacquard/stretch
 PIEDS: plastique ou bois

STRUTTURA: legno e derivati
 IMBOTTITURE: poliuretano espanso a densità diversificate (densità seduta: 30 kg/m³, densità schienale: 18 kg/m³)
 RIVESTIMENTO: tessuto o pelle
 SISTEMA-LETTO: rete elettrosaldata a doppia piega con materasso H14 cm rivestito in tessuto jacquard/stretch
 PIEDI: plastica o legno

STRUCTURE: wood and various by-products
 FILLING: expanded polyurethane foam with different densities (seat density: 30 kg/m³, back density: 18 kg/m³)
 COVERING: fabric or leather
 BED SYSTEM: electro-welded 2 folds bed mechanism with mattress H14 cm covered with jacquard/stretch fabric
 FEET: plastic or wood

Canapé-lit disponible avec plusieurs matelas
 Divano-letto disponibile con diversi materassi / Sofabed available with different mattresses

PAOLA

Matelas
 Materasso / Mattress
H14 cm

Assise
 Seduta / Seat
H48 cm



Canapés / Divani / Sofas	2P	3P	3P Maxi
Matelas / Materasso / Mattress	120 x 195	140 x 195	160 x 195
Encombrement maximal avec lit ouvert / Ingombro massimo aperto / Maximum size with open bed	190 x 210	210 x 210	230 x 210

Dimensions / Dimensioni / Dimensions:

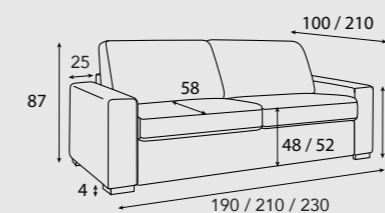

Toutes les dimensions ±3% / Tutte le dimensioni ±3% / All dimensions ±3%
 Dimensions en cm / Misure espresse in cm / Dimensions in cm

MODELE PATHOS

STRUCTURE: bois et dérivés
 REMBOURRAGE: polyuréthane expansé à densités diversifiées (densité assise: 30 kg/m³, densité dossier: 18 kg/m³)
 REVÊTEMENT: tissu ou cuir
 SYSTÈME-LIT: sommier électrosoudé double pliage avec matelas H14 cm en tissu jacquard/stretch
 PIEDS: plastique ou bois

STRUTTURA: legno e derivati
 IMBOTTITURE: poliuretano espanso a densità diversificate (densità seduta: 30 kg/m³, densità schienale: 18 kg/m³)
 RIVESTIMENTO: tessuto o pelle
 SISTEMA-LETTO: rete elettrosaldata a doppia piega con materasso H14 cm rivestito in tessuto jacquard/stretch
 PIEDI: plastica o legno

STRUCTURE: wood and various by-products
 FILLING: expanded polyurethane foam with different densities (seat density: 30 kg/m³, back density: 18 kg/m³)
 COVERING: fabric or leather
 BED SYSTEM: electro-welded 2 folds bed mechanism with mattress H14 cm covered with jacquard/stretch fabric
 FEET: plastic or wood

Canapé-lit disponible avec plusieurs matelas
 Divano-letto disponibile con diversi materassi / Sofabed available with different mattresses

PATHOS

Matelas
 Materasso / Mattress
H14 cm

Assise
 Seduta / Seat
H45 cm



Canapés / Divani / Sofas

2P

3P

3P Maxi

Matelas / Materasso / Mattress

120 x 195

140 x 195

160 x 195

Encombrement maximal avec lit ouvert /
 Ingombro massimo aperto /
 Maximum size with open bed

180 x 210

200 x 210

220 x 210

Dimensions / Dimensioni / Dimensions:

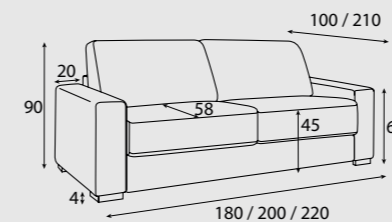

Toutes les dimensions ±3% / Tutte le dimensioni ±3% / All dimensions ±3%
 Dimensions en cm / Misure espresse in cm / Dimensions in cm

MODELE PATRASSO

STRUCTURE: bois et dérivés

REMOBLEMENT: polyuréthane expansé à densités diversifiées (densité assise: 30 kg/m³, densité dossier: 18 kg/m³)

REVÊTEMENT: tissu ou cuir

SYSTÈME-LIT: sommier électrosoudé double pliage avec matelas H14 cm en tissu jacquard/stretch

PIEDS: plastique ou bois

STRUTTURA: legno e derivati

IMBOTTITURE: poliuretano espanso a densità diversificate (densità seduta: 30 kg/m³, densità schienale: 18 kg/m³)

RIVESTIMENTO: tessuto o pelle

SISTEMA-LETTO: rete elettrosaldata a doppia piega con materasso H14 cm rivestito in tessuto jacquard/stretch

PIEDI: plastica o legno

STRUCTURE: wood and various by-products

FILLING: expanded polyurethane foam with different densities (seat density: 30 kg/m³, back density: 18 kg/m³)

COVERING: fabric or leather

BED SYSTEM: electro-welded 2 folds bed mechanism with mattress H14 cm covered with jacquard/stretch fabric

FEET: plastic or wood

Canapé-lit disponible avec plusieurs matelas

Divano-letto disponibile con diversi materassi / Sofabed available with different mattresses

PATRASSO

Matelas
Materasso / Mattress

H14 cm

Assise
Seduta / Seat

H46 cm



Canapés / Divani / Sofas

2P

3P

3P Maxi

Matelas / Materasso / Mattress

120 x 195

140 x 195

160 x 195

Encombrement maximal avec lit ouvert /
Ingombro massimo aperto /
Maximum size with open bed

173 x 210

193 x 210

213 x 210

Dimensions / Dimensioni / Dimensions:

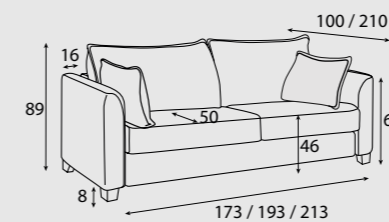

Toutes les dimensions ±3% / Tutte le dimensioni ±3% / All dimensions ±3%
Dimensions en cm / Misure espresse in cm / Dimensions in cm

MODELE PATRY

STRUCTURE: bois et dérivés

REMBOURRAGE: polyuréthane expansé à densités diversifiées (densité assise: 30 kg/m³, densité dossier: 18 kg/m³)

REVÊTEMENT: tissu ou cuir

SYSTÈME-LIT: sommier électrosoudé double pliage avec matelas H14 cm en tissu jacquard/stretch

PIEDS: plastique ou bois

STRUTTURA: legno e derivati

IMBOTTITURE: poliuretano espanso a densità diversificate (densità seduta: 30 kg/m³, densità schienale: 18 kg/m³)

RIVESTIMENTO: tessuto o pelle

SISTEMA-LETTO: rete elettrosaldata a doppia piega con materasso H14 cm rivestito in tessuto jacquard/stretch

PIEDI: plastica o legno

STRUCTURE: wood and various by-products

FILLING: expanded polyurethane foam with different densities (seat density: 30 kg/m³, back density: 18 kg/m³)

COVERING: fabric or leather

BED SYSTEM: electro-welded 2 folds bed mechanism with mattress H14 cm covered with jacquard/stretch fabric

FEET: plastic or wood

Canapé-lit disponible avec plusieurs matelas

Divano-letto disponibile con diversi materassi / Sofabed available with different mattresses

PATRY

Matelas
Materasso / Mattress

H14 cm

Assise
Seduta / Seat

H46 cm



Canapés / Divani / Sofas

2P

3P

3P Maxi

Matelas / Materasso / Mattress

120 x 195

140 x 195

160 x 195

Encombrement maximal avec lit ouvert /
Ingombro massimo aperto /
Maximum size with open bed

164 x 210

184 x 210

204 x 210

Dimensions / Dimensioni / Dimensions:

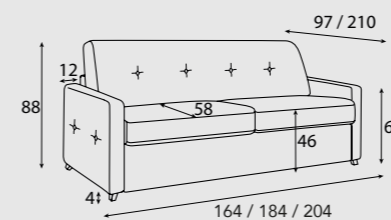

Toutes les dimensions ±3% / Tutte le dimensioni ±3% / All dimensions ±3%
Dimensions en cm / Misure espresse in cm / Dimensions in cm

MODELE PIREO

STRUCTURE: bois et dérivés
 REMBOURRAGE: polyuréthane expansé à densités diversifiées (densité assise: 30 kg/m³, densité dossier: 18 kg/m³)
 REVÊTEMENT: tissu ou cuir
 SYSTÈME-LIT: sommier électrosoudé double pliage avec matelas H14 cm en tissu jacquard/stretch
 PIEDS: plastique ou bois

STRUTTURA: legno e derivati
 IMBOTTITURE: poliuretano espanso a densità diversificate (densità seduta: 30 kg/m³, densità schienale: 18 kg/m³)
 RIVESTIMENTO: tessuto o pelle
 SISTEMA-LETTO: rete elettrosaldata a doppia piega con materasso H14 cm rivestito in tessuto jacquard/stretch
 PIEDI: plastica o legno

STRUCTURE: wood and various by-products
 FILLING: expanded polyurethane foam with different densities (seat density: 30 kg/m³, back density: 18 kg/m³)
 COVERING: fabric or leather
 BED SYSTEM: electro-welded 2 folds bed mechanism with mattress H14 cm covered with jacquard/stretch fabric
 FEET: plastic or wood

Canapé-lit disponible avec plusieurs matelas
 Divano-letto disponibile con diversi materassi / Sofabed available with different mattresses

PIREO

Matelas
 Materasso / Mattress
H14 cm

Assise
 Seduta / Seat
H45 cm



Canapés / Divani / Sofas	2P	3P	3P Maxi
Matelas / Materasso / Mattress	120 x 195	140 x 195	160 x 195
Encombrement maximal avec lit ouvert / Ingombro massimo aperto / Maximum size with open bed	156 x 210	176 x 210	196 x 210

Dimensions / Dimensioni / Dimensions:

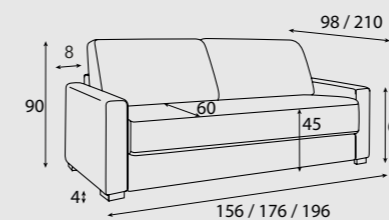

Toutes les dimensions ±3% / Tutte le dimensioni ±3% / All dimensions ±3%
 Dimensions en cm / Misure espresse in cm / Dimensions in cm

MODELE ROMINA

STRUCTURE: bois et dérivés
 REMBOURRAGE: polyuréthane expansé à densités diversifiées (densité assise: 30 kg/m³, densité dossier: 18 kg/m³)
 REVÊTEMENT: tissu ou cuir
 SYSTÈME-LIT: sommier électrosoudé double pliage avec matelas H14 cm en tissu jacquard/stretch
 PIEDS: plastique ou bois

STRUTTURA: legno e derivati
 IMBOTTITURE: poliuretano espanso a densità diversificate (densità seduta: 30 kg/m³, densità schienale: 18 kg/m³)
 RIVESTIMENTO: tessuto o pelle
 SISTEMA-LETTO: rete elettrosaldata a doppia piega con materasso H14 cm rivestito in tessuto jacquard/stretch
 PIEDI: plastica o legno

STRUCTURE: wood and various by-products
 FILLING: expanded polyurethane foam with different densities (seat density: 30 kg/m³, back density: 18 kg/m³)
 COVERING: fabric or leather
 BED SYSTEM: electro-welded 2 folds bed mechanism with mattress H14 cm covered with jacquard/stretch fabric
 FEET: plastic or wood

Canapé-lit disponible avec plusieurs matelas
 Divano-letto disponibile con diversi materassi / Sofabed available with different mattresses

ROMINA

Matelas
 Materasso / Mattress
H14 cm

Assise
 Seduta / Seat
H45 cm



Canapés / Divani / Sofas

2P

3P

3P Maxi

Matelas / Materasso / Mattress

120 x 195

140 x 195

160 x 195

Encombrement maximal avec lit ouvert /
 Ingombro massimo aperto /
 Maximum size with open bed

172 x 210

192 x 210

212 x 210

Dimensions / Dimensioni / Dimensions:

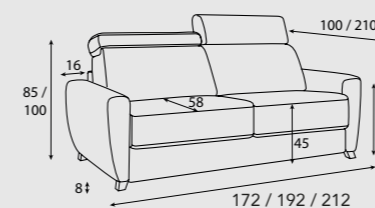

Toutes les dimensions ±3% / Tutte le dimensioni ±3% / All dimensions ±3%
 Dimensions en cm / Misure espresse in cm / Dimensions in cm

MODELE SANDRA

STRUCTURE: bois et dérivés

REMOBOURRAGE: polyuréthane expansé à densités diversifiées (densité assise: 30 kg/m³, densité dossier: 18 kg/m³)

REVÊTEMENT: tissu ou cuir

SYSTÈME-LIT: sommier électrosoudé double pliage avec matelas H14 cm en tissu jacquard/stretch

PIEDS: plastique ou bois

STRUTTURA: legno e derivati

IMBOTTITURE: poliuretano espanso a densità diversificate (densità seduta: 30 kg/m³, densità schienale: 18 kg/m³)

RIVESTIMENTO: tessuto o pelle

SISTEMA-LETTO: rete elettrosaldata a doppia piega con materasso H14 cm rivestito in tessuto jacquard/stretch

PIEDI: plastica o legno

STRUCTURE: wood and various by-products

FILLING: expanded polyurethane foam with different densities (seat density: 30 kg/m³, back density: 18 kg/m³)

COVERING: fabric or leather

BED SYSTEM: electro-welded 2 folds bed mechanism with mattress H14 cm covered with jacquard/stretch fabric

FEET: plastic or wood

Canapé-lit disponible avec plusieurs matelas

Divano-letto disponibile con diversi materassi / Sofabed available with different mattresses

SANDRA

Matelas
Materasso / Mattress
H14 cm

Assise
Seduta / Seat
H45 cm



Canapés / Divani / Sofas

2P

3P

3P Maxi

Matelas / Materasso / Mattress

120 x 195

140 x 195

160 x 195

Encombrement maximal avec lit ouvert /
Ingombro massimo aperto /
Maximum size with open bed

155 x 210

175 x 210

195 x 210

Dimensions / Dimensioni / Dimensions:

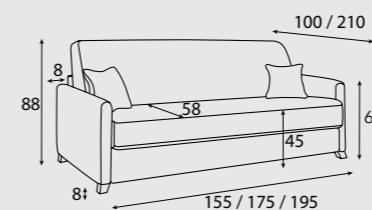

Toutes les dimensions ±3% / Tutte le dimensioni ±3% / All dimensions ±3%
Dimensions en cm / Misure espresse in cm / Dimensions in cm

MODELE SANTIAGO

STRUCTURE: bois et dérivés
 REMBOURRAGE: polyuréthane expansé à densités diversifiées (densité assise: 30 kg/m³, densité dossier: 18 kg/m³)
 REVÊTEMENT: tissu ou cuir
 SYSTÈME-LIT: sommier électrosoudé double pliage avec matelas H14 cm en tissu jacquard/stretch
 PIEDS: plastique ou bois

STRUTTURA: legno e derivati
 IMBOTTITURE: poliuretano espanso a densità diversificate (densità seduta: 30 kg/m³, densità schienale: 18 kg/m³)
 RIVESTIMENTO: tessuto o pelle
 SISTEMA-LETTO: rete elettrosaldata a doppia piega con materasso H14 cm rivestito in tessuto jacquard/stretch
 PIEDI: plastica o legno

STRUCTURE: wood and various by-products
 FILLING: expanded polyurethane foam with different densities (seat density: 30 kg/m³, back density: 18 kg/m³)
 COVERING: fabric or leather
 BED SYSTEM: electro-welded 2 folds bed mechanism with mattress H14 cm covered with jacquard/stretch fabric
 FEET: plastic or wood

Canapé-lit disponible avec plusieurs matelas
 Divano-letto disponibile con diversi materassi / Sofabed available with different mattresses

SANTIAGO

Matelas
 Materasso / Mattress
H14 cm

Assise
 Seduta / Seat
H48 cm



Canapés / Divani / Sofas

2P

3P

3P Maxi

Matelas / Materasso / Mattress

120 x 195

140 x 195

160 x 195

Encombrement maximal avec lit ouvert /
 Ingombro massimo aperto /
 Maximum size with open bed

170 x 210

190 x 210

210 x 210

Dimensions / Dimensioni / Dimensions:

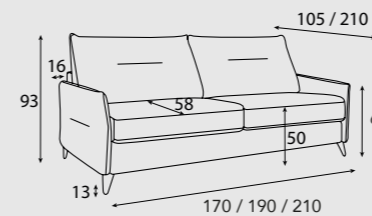

Toutes les dimensions ±3% / Tutte le dimensioni ±3% / All dimensions ±3%
 Dimensions en cm / Misure espresse in cm / Dimensions in cm

MODELE SELENE

STRUCTURE: bois et dérivés

REMBOURRAGE: polyuréthane expansé à densités diversifiées (densité assise: 30 kg/m³, densité dossier: 18 kg/m³)

REVÊTEMENT: tissu ou cuir

SYSTÈME-LIT: sommier électrosoudé double pliage avec matelas H14 cm en tissu jacquard/stretch

PIEDS: plastique ou bois

STRUTTURA: legno e derivati

IMBOTTITURE: poliuretano espanso a densità diversificate (densità seduta: 30 kg/m³, densità schienale: 18 kg/m³)

RIVESTIMENTO: tessuto o pelle

SISTEMA-LETTO: rete elettrosaldata a doppia piega con materasso H14 cm rivestito in tessuto jacquard/stretch

PIEDI: plastica o legno

STRUCTURE: wood and various by-products

FILLING: expanded polyurethane foam with different densities (seat density: 30 kg/m³, back density: 18 kg/m³)

COVERING: fabric or leather

BED SYSTEM: electro-welded 2 folds bed mechanism with mattress H14 cm covered with jacquard/stretch fabric

FEET: plastic or wood

Canapé-lit disponible avec plusieurs matelas

Divano-letto disponibile con diversi materassi / Sofabed available with different mattresses

SELENE

Matelas
Materasso / Mattress

H14 cm

Assise
Seduta / Seat

H50 cm



Canapés / Divani / Sofas

2P

3P

3P Maxi

Matelas / Materasso / Mattress

120 x 195

140 x 195

160 x 195

Encombrement maximal avec lit ouvert /
Ingombro massimo aperto /
Maximum size with open bed

172 x 210

192 x 210

212 x 210

Dimensions / Dimensioni / Dimensions:

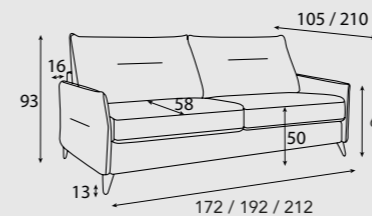

Toutes les dimensions ±3% / Tutte le dimensioni ±3% / All dimensions ±3%
Dimensions en cm / Misure espresse in cm / Dimensions in cm

MODELE SKY

STRUCTURE: bois et dérivés
 REMBOURRAGE: polyuréthane expansé à densités diversifiées (densité assise: 30 kg/m³, densité dossier: 18 kg/m³)
 REVÊTEMENT: tissu ou cuir
 SYSTÈME-LIT: sommier électrosoudé double pliage avec matelas H14 cm en tissu jacquard/stretch
 PIEDS: plastique ou bois

STRUTTURA: legno e derivati
 IMBOTTITURE: poliuretano espanso a densità diversificate (densità seduta: 30 kg/m³, densità schienale: 18 kg/m³)
 RIVESTIMENTO: tessuto o pelle
 SISTEMA-LETTO: rete elettrosaldata a doppia piega con materasso H14 cm rivestito in tessuto jacquard/stretch
 PIEDI: plastica o legno

STRUCTURE: wood and various by-products
 FILLING: expanded polyurethane foam with different densities (seat density: 30 kg/m³, back density: 18 kg/m³)
 COVERING: fabric or leather
 BED SYSTEM: electro-welded 2 folds bed mechanism with mattress H14 cm covered with jacquard/stretch fabric
 FEET: plastic or wood

Canapé-lit disponible avec plusieurs matelas
 Divano-letto disponibile con diversi materassi / Sofabed available with different mattresses

SKY
 Matelas
 Materasso / Mattress
H14 cm
 Assise
 Seduta / Seat
H45 cm



Option poche / Tasca opzionale / Pocket option



Canapés / Divani / Sofas	2P	3P	3P Maxi
Matelas / Materasso / Mattress	120 x 195	140 x 195	160 x 195
Encombrement maximal avec lit ouvert / Ingombro massimo aperto / Maximum size with open bed	172 x 210	192 x 210	212 x 210

Dimensions / Dimensioni / Dimensions:

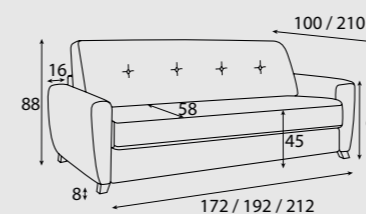

Option poche / Tasca opzionale / Pocket option



Toutes les dimensions ±3% / Tutte le dimensioni ±3% / All dimensions ±3%
 Dimensions en cm / Misure espresse in cm / Dimensions in cm

MODELE STRIKE

STRUCTURE: bois et dérivés

REMBOURRAGE: polyuréthane expansé à densités diversifiées (densité assise: 30 kg/m³, densité dossier: 18 kg/m³)

REVÊTEMENT: tissu ou cuir

SYSTÈME-LIT: sommier électrosoudé double pliage avec matelas H14 cm en tissu jacquard/stretch

PIEDS: plastique ou bois

STRUTTURA: legno e derivati

IMBOTTITURE: poliuretano espanso a densità diversificate (densità seduta: 30 kg/m³, densità schienale: 18 kg/m³)

RIVESTIMENTO: tessuto o pelle

SISTEMA-LETTO: rete elettrosaldata a doppia piega con materasso H14 cm rivestito in tessuto jacquard/stretch

PIEDI: plastica o legno

STRUCTURE: wood and various by-products

FILLING: expanded polyurethane foam with different densities (seat density: 30 kg/m³, back density: 18 kg/m³)

COVERING: fabric or leather

BED SYSTEM: electro-welded 2 folds bed mechanism with mattress H14 cm covered with jacquard/stretch fabric

FEET: plastic or wood

Canapé-lit disponible avec plusieurs matelas

Divano-letto disponibile con diversi materassi / Sofabed available with different mattresses

STRIKE

Matelas
Materasso / Mattress
H14 cm

Assise
Seduta / Seat
H44 cm



Canapés / Divani / Sofas

2P

3P

3P Maxi

Matelas / Materasso / Mattress

120 x 195

140 x 195

160 x 195

Encombrement maximal avec lit ouvert /
Ingombro massimo aperto /
Maximum size with open bed

155 x 210

175 x 210

195 x 210

Dimensions / Dimensioni / Dimensions:

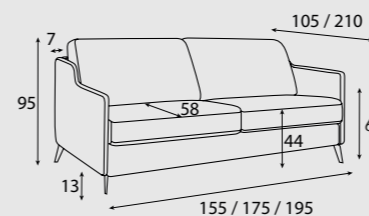

Toutes les dimensions ±3% / Tutte le dimensioni ±3% / All dimensions ±3%
Dimensions en cm / Misure espresse in cm / Dimensions in cm

MODELE TOM

STRUCTURE: bois et dérivés
 REMBOURRAGE: polyuréthane expansé à densités diversifiées (densité assise: 30 kg/m³, densité dossier: 18 kg/m³)
 REVÊTEMENT: tissu ou cuir
 SYSTÈME-LIT: sommier électrosoudé double pliage avec matelas H14 cm en tissu jacquard/stretch
 PIEDS: plastique ou bois

STRUTTURA: legno e derivati
 IMBOTTITURE: poliuretano espanso a densità diversificate (densità seduta: 30 kg/m³, densità schienale: 18 kg/m³)
 RIVESTIMENTO: tessuto o pelle
 SISTEMA-LETTO: rete elettrosaldata a doppia piega con materasso H14 cm rivestito in tessuto jacquard/stretch
 PIEDI: plastica o legno

STRUCTURE: wood and various by-products
 FILLING: expanded polyurethane foam with different densities (seat density: 30 kg/m³, back density: 18 kg/m³)
 COVERING: fabric or leather
 BED SYSTEM: electro-welded 2 folds bed mechanism with mattress H14 cm covered with jacquard/stretch fabric
 FEET: plastic or wood

Canapé-lit disponible avec plusieurs matelas
 Divano-letto disponibile con diversi materassi / Sofabed available with different mattresses

TOM
 Matelas
 Materasso / Mattress
H14 cm
 Assise
 Seduta / Seat
H48 cm



Canapés / Divani / Sofas	2P	3P	3P Maxi
Matelas / Materasso / Mattress	120 x 195	140 x 195	160 x 195
Encombrement maximal avec lit ouvert / Ingombro massimo aperto / Maximum size with open bed	165 x 210	185 x 210	205 x 210

Dimensions / Dimensioni / Dimensions:

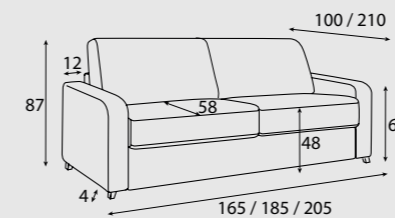

Toutes les dimensions ±3% / Tutte le dimensioni ±3% / All dimensions ±3%
 Dimensions en cm / Misure espresse in cm / Dimensions in cm

MATELAS / MATERASSI / MATTRESSES

MODELLO 1 / MODELE 1 / MODEL 1

STANDARD PAR QUANTITÉS /
STANDARD A QUANTITÀ /
STANDARD BIG QUANTITIES



Altezza
Hauteur / Height
14 cm
Densità
Densité / Density
28 Kg/m³
Rivestimento
Revêtement / Cover
Jacquard

MODELLO 3 / MODELE 3 / MODEL 3

OPTION 2 (stretch 2 passepoils) /
OPZIONE 2 (stretch doppio bordino) /
OPTION 2 (stretch double piping)



Altezza
Hauteur / Height
14 cm
Densità
Densité / Density
35 Kg/m³
Rivestimento
Revêtement / Cover
Stretch

MODELLO 2 / MODELE 2 / MODEL 2

STANDARD À LA CONTREMARQUE /
STANDARD A RIFERIMENTO /
STANDARD REFERENCE ORDERS



Altezza
Hauteur / Height
14 cm
Densità
Densité / Density
30 Kg/m³
Rivestimento
Revêtement / Cover
Jacquard

MODELLO 4 / MODELE 4 / MODEL 4

OPTION 3 (stretch memory 2 passepoils) /
OPZIONE 3 (stretch memory doppio bordino) /
OPTION 3 (Memory stretch double piping)



Altezza
Hauteur / Height
14 cm
Densità
Densité / Density
**30 Kg/m³ + 4 cm
memory d. 50 Kg/m³**
Rivestimento
Revêtement / Cover
Stretch



MODELE GLAMOUR

STRUCTURE: bois et dérivés
 REMBOURRAGE: polyuréthane expansé à densités diversifiées (densité assise: 30 kg/m³, densité dossier: 18 kg/m³)
 REVÊTEMENT: tissu ou cuir
 PIEDS: plastique, bois ou métal

STRUTTURA: legno e derivati
 IMBOTTITURE: poliuretano espanso a densità diversificate (densità seduta: 30 kg/m³, densità schienale: 18 kg/m³)
 RIVESTIMENTO: tessuto o pelle
 PIEDI: plastica, legno o metallo

STRUCTURE: wood and various by-products
 FILLING: expanded polyurethane foam with different densities (seat density: 30 kg/m³, back density: 18 kg/m³)
 COVERING: fabric or leather
 FEET: plastic, wood or metal

MODELE LOFT

STRUCTURE: bois et dérivés
 REMBOURRAGE: polyuréthane expansé à densités diversifiées (densité assise: 30 kg/m³, densité dossier: 18 kg/m³)
 REVÊTEMENT: tissu ou cuir
 PIEDS: plastique, bois ou métal

STRUTTURA: legno e derivati
 IMBOTTITURE: poliuretano espanso a densità diversificate (densità seduta: 30 kg/m³, densità schienale: 18 kg/m³)
 RIVESTIMENTO: tessuto o pelle
 PIEDI: plastica, legno o metallo

STRUCTURE: wood and various by-products
 FILLING: expanded polyurethane foam with different densities (seat density: 30 kg/m³, back density: 18 kg/m³)
 COVERING: fabric or leather
 FEET: plastic, wood or metal



Dimensions en cm / Misure espresse in cm / Dimensions in cm

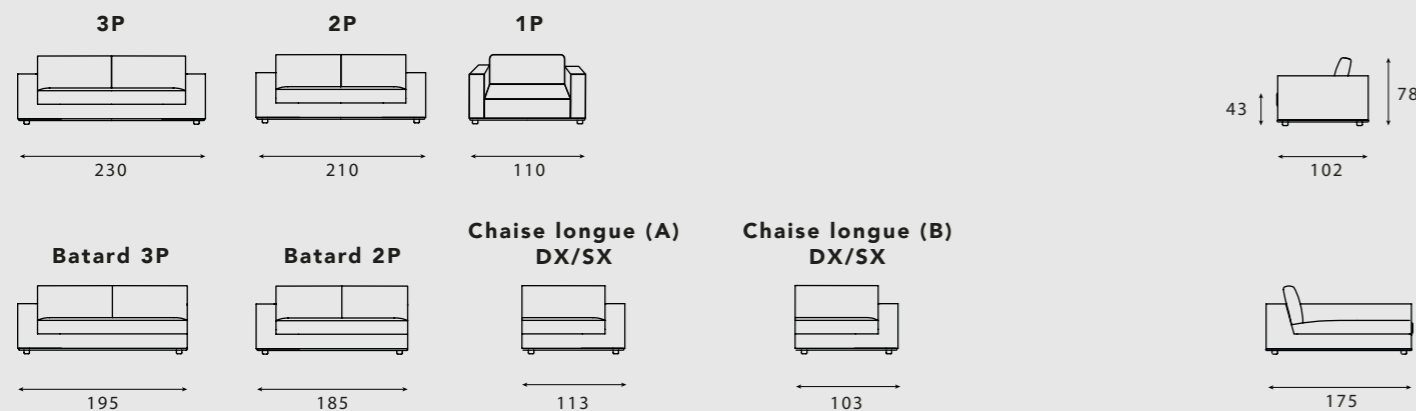

Dimensions en cm / Misure espresse in cm / Dimensions in cm

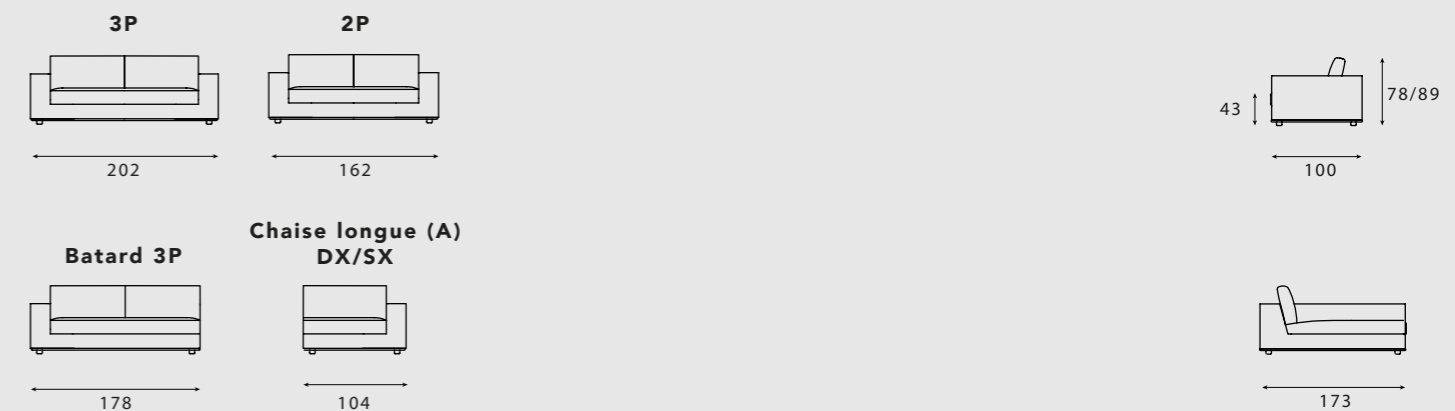

MODELE LORY

STRUCTURE: bois et dérivés

REMBOURRAGE: polyuréthane expansé à densités diversifiées (densité assise: 30 kg/m³, densité dossier: 18 kg/m³)

REVÊTEMENT: tissu ou cuir

PIEDS: plastique, bois ou métal

STRUTTURA: legno e derivati

IMBOTTITURE: poliuretano espanso a densità diversificate (densità seduta: 30 kg/m³, densità schienale: 18 kg/m³)

RIVESTIMENTO: tessuto o pelle

PIEDI: plastica, legno o metallo

STRUCTURE: wood and various by-products

FILLING: expanded polyurethane foam with different densities (seat density: 30 kg/m³, back density: 18 kg/m³)

COVERING: fabric or leather

FEET: plastic, wood or metal

MODELE MERCURE

STRUCTURE: bois et dérivés

REMBOURRAGE: polyuréthane expansé à densités diversifiées (densité assise: 30 kg/m³, densité dossier: 18 kg/m³)

REVÊTEMENT: tissu ou cuir

PIEDS: plastique, bois ou métal

STRUTTURA: legno e derivati

IMBOTTITURE: poliuretano espanso a densità diversificate (densità seduta: 30 kg/m³, densità schienale: 18 kg/m³)

RIVESTIMENTO: tessuto o pelle

PIEDI: plastica, legno o metallo

STRUCTURE: wood and various by-products

FILLING: expanded polyurethane foam with different densities (seat density: 30 kg/m³, back density: 18 kg/m³)

COVERING: fabric or leather

FEET: plastic, wood or metal



Dimensions en cm / Misure espresse in cm / Dimensions in cm

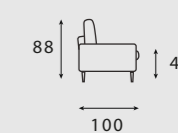
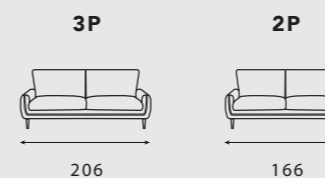
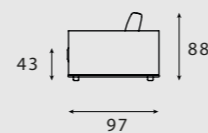
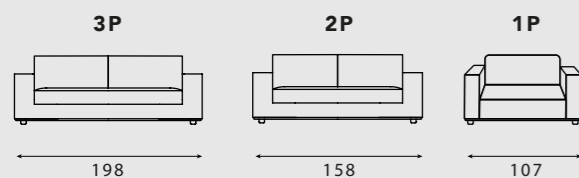

Dimensions en cm / Misure espresse in cm / Dimensions in cm

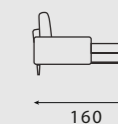

MODELE MIMOSA

STRUCTURE: bois et dérivés
 REMBOURRAGE: polyuréthane expansé à densités diversifiées (densité assise: 30 kg/m³, densité dossier: 18 kg/m³)
 REVÊTEMENT: tissu ou cuir
 PIEDS: plastique, bois ou métal

STRUTTURA: legno e derivati
 IMBOTTITURE: poliuretano espanso a densità diversificate (densità seduta: 30 kg/m³, densità schienale: 18 kg/m³)
 RIVESTIMENTO: tessuto o pelle
 PIEDI: plastica, legno o metallo

STRUCTURE: wood and various by-products
 FILLING: expanded polyurethane foam with different densities (seat density: 30 kg/m³, back density: 18 kg/m³)
 COVERING: fabric or leather
 FEET: plastic, wood or metal



MODELE NEW CLARA

STRUCTURE: bois et dérivés
 REMBOURRAGE: polyuréthane expansé à densités diversifiées (densité assise: 30 kg/m³, densité dossier: 18 kg/m³)
 REVÊTEMENT: tissu ou cuir
 PIEDS: plastique, bois ou métal

STRUTTURA: legno e derivati
 IMBOTTITURE: poliuretano espanso a densità diversificate (densità seduta: 30 kg/m³, densità schienale: 18 kg/m³)
 RIVESTIMENTO: tessuto o pelle
 PIEDI: plastica, legno o metallo

STRUCTURE: wood and various by-products
 FILLING: expanded polyurethane foam with different densities (seat density: 30 kg/m³, back density: 18 kg/m³)
 COVERING: fabric or leather
 FEET: plastic, wood or metal



Dimensions en cm / Misure espresse in cm / Dimensions in cm

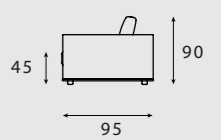
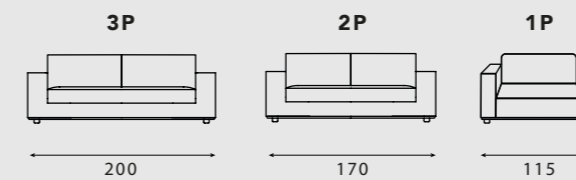
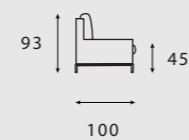
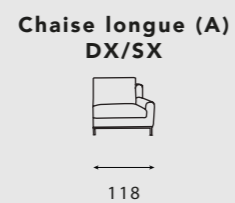
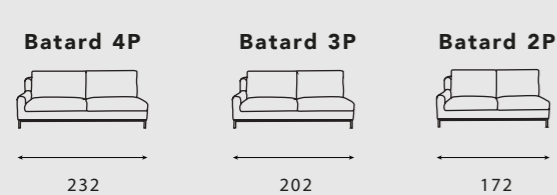
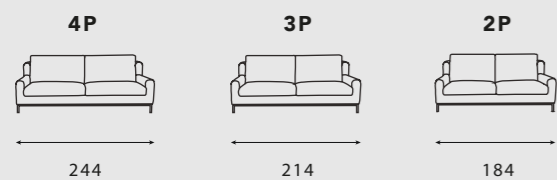

MODELE NEW VOGUE

STRUCTURE: bois et dérivés
 REMBOURRAGE: polyuréthane expansé à densités diversifiées (densité assise: 30 kg/m³, densité dossier: 18 kg/m³)
 REVÊTEMENT: tissu ou cuir
 PIEDS: plastique, bois ou métal

STRUTTURA: legno e derivati
 IMBOTTITURE: poliuretano espanso a densità diversificate (densità seduta: 30 kg/m³, densità schienale: 18 kg/m³)
 RIVESTIMENTO: tessuto o pelle
 PIEDI: plastica, legno o metallo

STRUCTURE: wood and various by-products
 FILLING: expanded polyurethane foam with different densities (seat density: 30 kg/m³, back density: 18 kg/m³)
 COVERING: fabric or leather
 FEET: plastic, wood or metal



MODELE PONZA

STRUCTURE: bois et dérivés
 REMBOURRAGE: polyuréthane expansé à densités diversifiées (densité assise: 30 kg/m³, densité dossier: 18 kg/m³)
 REVÊTEMENT: tissu ou cuir
 PIEDS: plastique, bois ou métal

STRUTTURA: legno e derivati
 IMBOTTITURE: poliuretano espanso a densità diversificate (densità seduta: 30 kg/m³, densità schienale: 18 kg/m³)
 RIVESTIMENTO: tessuto o pelle
 PIEDI: plastica, legno o metallo

STRUCTURE: wood and various by-products
 FILLING: expanded polyurethane foam with different densities (seat density: 30 kg/m³, back density: 18 kg/m³)
 COVERING: fabric or leather
 FEET: plastic, wood or metal



Dimensions en cm / Misure espresse in cm / Dimensions in cm

3P

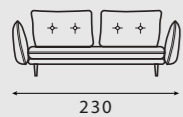

Batard 3P

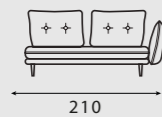

Schienale volante mobile

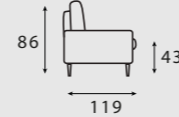

1P



Schienale fisso basculante



Chaise longue (A) DX/SX

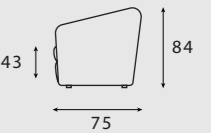
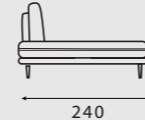

Dimensions en cm / Misure espresse in cm / Dimensions in cm

MODELE SPACE

STRUCTURE: bois et dérivés

REMBOURRAGE: polyuréthane expansé à densités diversifiées (densité assise: 30 kg/m³, densité dossier: 18 kg/m³)

REVÊTEMENT: tissu ou cuir

PIEDS: plastique, bois ou métal

STRUTTURA: legno e derivati

IMBOTTITURE: poliuretano espanso a densità diversificate (densità seduta: 30 kg/m³, densità schienale: 18 kg/m³)

RIVESTIMENTO: tessuto o pelle

PIEDI: plastica, legno o metallo

STRUCTURE: wood and various by-products

FILLING: expanded polyurethane foam with different densities (seat density: 30 kg/m³, back density: 18 kg/m³)

COVERING: fabric or leather

FEET: plastic, wood or metal

MODELE SUN

STRUCTURE: bois et dérivés

REMBOURRAGE: polyuréthane expansé à densités diversifiées (densité assise: 30 kg/m³, densité dossier: 18 kg/m³)

REVÊTEMENT: tissu ou cuir

PIEDS: plastique, bois ou métal

STRUTTURA: legno e derivati

IMBOTTITURE: poliuretano espanso a densità diversificate (densità seduta: 30 kg/m³, densità schienale: 18 kg/m³)

RIVESTIMENTO: tessuto o pelle

PIEDI: plastica, legno o metallo

STRUCTURE: wood and various by-products

FILLING: expanded polyurethane foam with different densities (seat density: 30 kg/m³, back density: 18 kg/m³)

COVERING: fabric or leather

FEET: plastic, wood or metal



Dimensions en cm / Misure espresse in cm / Dimensions in cm

ELEMENT 200 ELEMENT 100 ELEMENT 100 ELEMENT 80

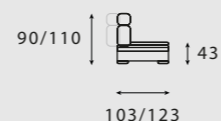

Bras



Angle



Chaise longue (A)
DX/SX



Dimensions en cm / Misure espresse in cm / Dimensions in cm

4P 3P 2P Angle

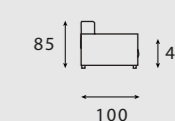
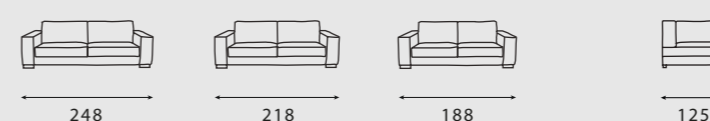

Batard 4P Batard 3P Batard 2P

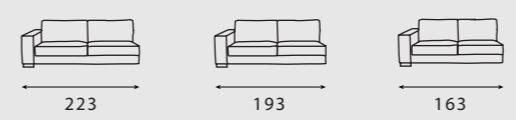

Chaise longue (A)
DX/SX

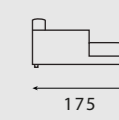
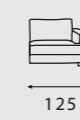

MODELE VIVIANE

STRUCTURE: bois et dérivés
 REMBOURRAGE: polyuréthane expansé à densités diversifiées (densité assise: 30 kg/m³, densité dossier: 18 kg/m³)
 REVÊTEMENT: tissu ou cuir
 PIEDS: plastique, bois ou métal

STRUTTURA: legno e derivati
 IMBOTTITURE: poliuretano espanso a densità diversificate (densità seduta: 30 kg/m³, densità schienale: 18 kg/m³)
 RIVESTIMENTO: tessuto o pelle
 PIEDI: plastica, legno o metallo

STRUCTURE: wood and various by-products
 FILLING: expanded polyurethane foam with different densities (seat density: 30 kg/m³, back density: 18 kg/m³)
 COVERING: fabric or leather
 FEET: plastic, wood or metal



Dimensions en cm / Misure espresse in cm / Dimensions in cm

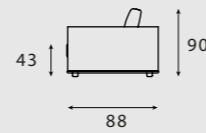
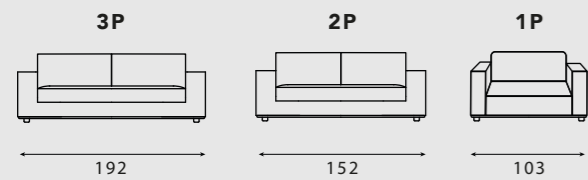

ARMOIRE LIT / ARMADIO-LETTO / WALL BED:

Il s'agit de produits de haute qualité avec un design moderne et fonctionnel, qui s'adaptent à toutes les ambiances et ils sont idéaux pour optimiser les petits espaces.

Prodotti di alta qualità dal design giovane e funzionale, si adattano a ogni tipo di ambiente e sono perfetti per arredare e ottimizzare i piccoli spazi.

High quality products with a modern and functional design, fitting every living space and especially developed for optimizing small rooms.

ÉLÉMENTS / ELEMENTI / ELEMENTS:

- Meuble bibliothèque /
Mobile libreria / Bookcase unit

- Armoire lit /
Armadio-letto / Wall bed

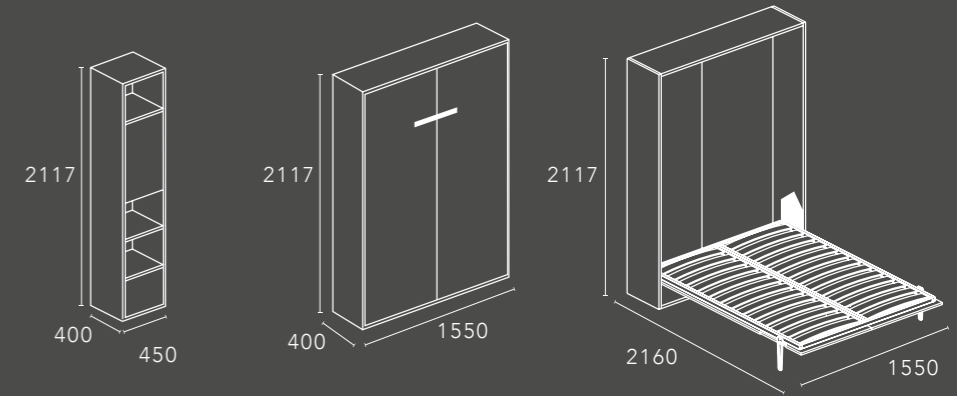

Armoire lit escamotable / Armadio letto / Wall bed

L. 1550 mm – P. armoire fermé 400 mm – P. armoire ouvert 2160 mm – H. 2117 mm

L. 1550 mm – P. armadio chiuso 400 mm – P. armadio aperto 2160 mm – H. 2117 mm

W. 1550 mm – D. closed wall bed 400 mm – D. open wall bed 2160 mm – H. 2117 mm

COMBO_1



Armoire lit escamotable avec meuble bibliothèque /
Armadio letto con mobile biblioteca / Wall bed with a
bookcase unit

L. 2000 mm – P. armoire fermé 400 mm – P. armoire ouvert 2160 mm – H. 2117 mm

L. 2000 mm – P. armadio chiuso 400 mm – P. armadio aperto 2160 mm – H. 2117 mm

W. 2000 mm – D. closed wall bed 400 mm – D. open wall bed 2160 mm – H. 2117 mm

COMBO_2



Armoire lit escamotable avec deux meubles bibliothèque
d'un côté / Armadio letto con due mobili biblioteca a
lato / Wall bed with two bookcase units at one side

L. 2450 mm – P. armoire fermé 400 mm – P. armoire ouvert 2160 mm – H. 2117 mm

L. 2450 mm – P. armadio chiuso 400 mm – P. armadio aperto 2160 mm – H. 2117 mm

W. 2450 mm – D. closed wall bed 400 mm – P. open wall bed 2160 mm – H. 2117 mm

COMBO_3



Armoire lit escamotable avec deux meubles bibliothèque
à droite et à gauche / Armadio letto con due mobili bi-
blioteca a destra e sinistra / Wall bed with two bookca-
se units on the right and on the left

L. 2450 mm – P. armoire fermé 400 mm – P. armoire ouvert 2160 mm – H. 2117 mm

L. 2450 mm – P. armadio chiuso 400 mm – P. armadio aperto 2160 mm – H. 2117 mm

W. 2450 mm – D. closed wall bed 400 mm – P. open wall bed 2160 mm – H. 2117 mm

COMBO_4



**COULEURS FAÇADE DISPONIBLES /
 COLORAZIONI ANTE DISPONIBILI /
 FRONT PANELS AVAILABLE COLOURS:**

**COULEURS STRUCTURE DISPONIBLES /
 COLORAZIONI STRUTTURA DISPONIBILI /
 STRUCTURE AVAILABLE COLOURS:**

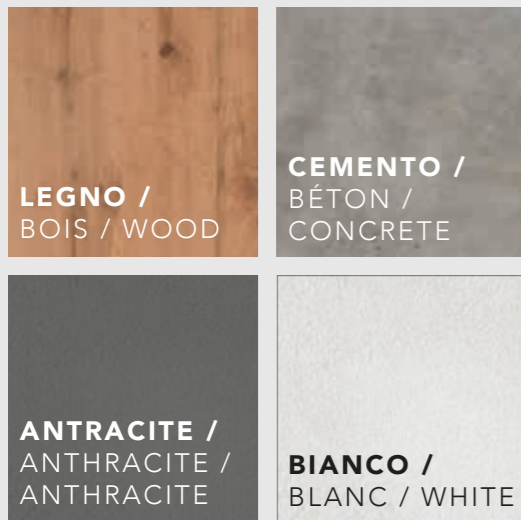

Façades *en gris* /
 Ante *in grigio* /
 Front panels *in grey colour*

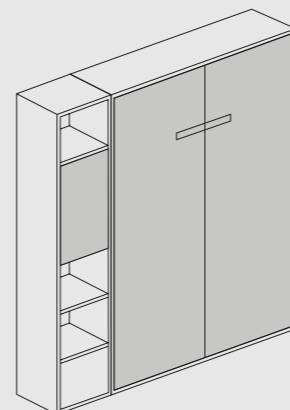

Structure *en gris* /
 Struttura *in grigio* /
 Structure *in grey colour*

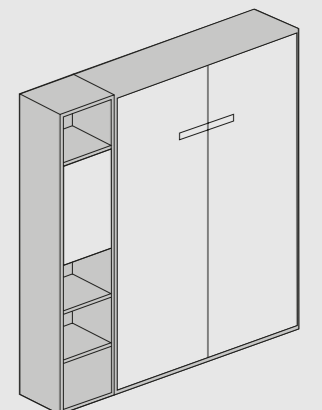

SOMMIERS / SOMMIER / BOX-SPRINGS

Sommier rembourré et revêtu en tissu, disponible en 2 versions avec épaisseur de 14 et de 19 cm. Revêtement au choix dans la même gamme de tissus de lits et de têtes de lit. Un soutien idéal pour ceux qui veulent reposer confortablement. Il est réalisé artisanalement avec des matières premières de haute qualité. Fourni avec ou sans pieds.

Sommier in tessuto semplice e funzionale, disponibile in 2 versioni, con spessore di 14 cm e 19 cm. Ampia scelta di tessuti (gli stessi tessuti sono disponibili per letti e testate). Il miglior supporto per le vostre notti di sonno confortevoli, realizzato a mano con materiali di alta qualità e disponibile con o senza piedi.

Simple and functional fabric box-spring, available in 2 versions, 14 cm and 19 cm thick. Large selection of fabrics (same fabrics available for beds and headboards). The best support for your comfortable sleeping nights, handmade with top quality materials and available with or without legs.

VÉRSIONS DISPONIBLES /
VERSIONI DISPONIBILI / AVAILABLE VERSIONS:



N.B.: PIEDS NON INCLUS / PIEDI NON INCLUSI / FEET NOT INCLUDED



SOMMIER
H19 cm



SOMMIER
H14 cm



TESTATE / TÊTES DE LIT / HEADBOARDS

Choix parmi différentes têtes de lit assorties avec tous nos lits et tous nos sommiers, revêtement en tissu, élégance assurée.

Possibilità di scegliere fra diverse testate abbinabili a tutti i nostri letti e a tutti i nostri sommier. Rivestimento in tessuto, eleganza assicurata.

Different headboards available, which can be matched to all our beds and to all our box-springs. With fabric coverings, elegance is always guaranteed.



MODELE N.2
MODELLO N.2 / MODEL N.2

L. 140/160/170/180 cm – P. 10 cm – H. 110 cm
L. 140/160/170/180 cm – P. 10 cm – H. 110 cm
W. 140/160/170/180 cm – P. 10 cm – H. 110 cm



MODELE N.4
MODELLO N.4 / MODEL N.4

L. 140/160/170/180 cm – P. 10 cm – H. 110 cm
L. 140/160/170/180 cm – P. 10 cm – H. 110 cm
W. 140/160/170/180 cm – P. 10 cm – H. 110 cm



MODELE N.5
MODELLO N.5 / MODEL N.5

L. 140/160/170/180 cm – P. 10 cm – H. 110 cm
L. 140/160/170/180 cm – P. 10 cm – H. 110 cm
W. 140/160/170/180 cm – P. 10 cm – H. 110 cm



MODELE TORINO
MODELLO TORINO /
MODEL TORINO

L. 140/160/170/180 cm – P. 6 cm – H. 110 cm
L. 140/160/170/180 cm – P. 6 cm – H. 110 cm
W. 140/160/170/180 cm – P. 6 cm – H. 110 cm

CONDITIONS GENERALES DE VENTE

- Toutes les commandes (signées par les clients et avec leur coordonnées exactes) seront à envoyer par mail, aucune commande téléphonique ne sera prise en charge. Le client doit toujours s'assurer de recevoir une confirmation de commande pour chaque commande envoyée (sans confirmation de commande de notre part la commande n'est pas prise en charge)
- A la réception de la marchandise le client doit en contrôler l'état. Tous les produits défectueux doivent être signalés sous 8 jours. Aucune réclamation concernant des anomalies de livraison ne sera acceptée après ce délai.
- Nos produits sont garantis pour 2 ans, exclusivement pour des défauts de fabrication. Cette garantie ne couvre pas les problèmes causés par une mauvaise utilisation (griffures et coutures ouvertes qui n'étaient pas présentes au moment de la livraison, utilisation de mauvais produits de nettoyage, etc...).
- Pour procéder à la prise en charge de chaque SAV il nous faut impérativement une fiche SAV remplie correctement (avec la référence de notre facture de vente et des photos du problème).
- Si on doit prévoir l'échange du produit ou bien un retour usine pour réparation c'est le revendeur qui doit s'occuper de la reprise du canapé de chez le particulier: nos transporteurs n'effectuent pas de reprises à domicile. Une fois récupérée de chez le client particulier la marchandise devra être bien emballée et mise à disposition de notre transporteur au magasin ou bien dans une plate-forme logistique.
- Notre fabrication, étant artisanale, peut survenir avec des petites différences jusqu'à 3% au niveau des dimensions. Nous nous réservons aussi le droit d'apporter des petites modifications pour améliorer les produits. De plus, en raison de la complexité de mise au point du tissu, nous ne pouvons pas garantir un coloris identique entre 2 commandes passées dans 2 moments différents (il peut également exister une légère différence de nuance entre le coloris du revêtement du produit commandé et celui du tissu correspondant de notre liasse d'échantillons)

CONDIZIONI GENERALI DI VENDITA

- Tutti gli ordini (firmati dai clienti e con i loro dati di contatto esatti) devono essere inviati via e-mail, non saranno accettati ordini telefonici. Il cliente deve sempre assicurarsi di ricevere una conferma d'ordine per ogni ordine inviato (senza una conferma d'ordine da parte nostra l'ordine non verrà elaborato).
- Al ricevimento della merce, il cliente deve verificare le condizioni della merce. Tutti i prodotti difettosi devono essere segnalati entro 8 giorni. Dopo questo periodo non saranno accettati reclami relativi ad anomalie nella consegna.
- I nostri prodotti sono in garanzia per 2 anni, esclusivamente per i difetti di fabbricazione. Questa garanzia non copre i problemi causati da un uso improprio (graffi e cuciture aperte che non erano presenti al momento della consegna, uso di prodotti di pulizia sbagliati, ecc.)
- Per procedere alla gestione di ogni servizio post-vendita, abbiamo bisogno di un modulo di assistenza post-vendita correttamente compilato (con il riferimento della nostra fattura di vendita e le foto del problema).
- Se il prodotto deve essere sostituito o restituito alla fabbrica per la riparazione, il rivenditore deve occuparsi del ritiro del divano presso il domicilio del cliente: i nostri corrieri non effettuano il ritiro a domicilio. Una volta ritirata dal domicilio del cliente, la merce deve essere ben imballata e messa a disposizione del nostro corriere presso il negozio o una piattaforma logistica.
- La nostra produzione, essendo artigianale, può presentare piccole differenze fino al 3% nelle dimensioni. Ci riserviamo inoltre il diritto di apportare piccole modifiche per migliorare i prodotti. Inoltre, a causa della complessità dello sviluppo dei tessuti, non possiamo garantire un colore identico tra 2 ordini effettuati in 2 momenti diversi (potrebbe anche esserci una leggera differenza di tonalità tra il colore del rivestimento del prodotto ordinato e quello del tessuto corrispondente nel nostro campionario).

GENERAL CONDITIONS OF SALE

- All orders (signed by the customers and with their exact contact details) must be sent by email, no telephone orders will be taken. The customer must always make sure to receive an order confirmation for each order sent (without an order confirmation from us the order will not be processed).
- Upon receipt of the goods, the customer must check the condition of the goods. All defective products must be reported within 8 days. No claims regarding delivery anomalies will be accepted after this period.
- Our products are guaranteed for 2 years, exclusively for manufacturing defects. This guarantee does not cover problems caused by misuse (scratches and open seams that were not present at the time of delivery, use of the wrong cleaning products, etc.).
- To proceed with the handling of each claim, we need a correctly filled document in claim form (with the reference of our sales invoice and photos of the problem)
- If the product has to be exchanged or returned to the factory for repair, the retailer has to take care of the collection of the sofa from the customer's home: our carriers do not carry out home collection. Once the goods have been collected from the customer's home, they must be well packaged and made available to our carrier at the shop or at a logistics platform.
- As we manufacture our products by hand, it is always possible to have small differences of up to 3% in the dimensions. We also reserve the right to make small changes to improve the products. Furthermore, due to the complexity of fabric development, we cannot guarantee an identical colour between 2 orders placed at 2 different times (there may also be a slight difference in shade between the colour of the covering of the product ordered and that of the corresponding fabric in our sample pack).

Les couleurs des revêtements et des pièces en bois ou en métal photographiées dans ce catalogue doivent être considérées comme purement indicatives. Les procédés photographiques et d'impression utilisés ne garantissent pas une fidélité totale des couleurs à l'aspect réel, c'est pourquoi toutes les commandes doivent être vérifiées à l'aide de nos échantillons (tissu ou cuir).

I colori relativi ai rivestimenti e alle parti in legno o metallo fotografati su questo catalogo sono da considerarsi puramente indicativi. I procedimenti di fotografia e stampa utilizzati non garantiscono la totale fedeltà cromatica all'aspetto reale, quindi tutti gli ordini devono essere verificati sui nostri campionari (pelle o tessuto).

Covering colours and wood or metal parts which are photographed in this catalogue are to be considered purely indicative. The photographic and printing processes do not guarantee total colour fidelity to the real appearance, therefore all orders must be checked against our fabric or leather samples.



MONDO SOFA GROUP SRL

Via Tratturo 80
47032 Bertinoro (FC) Italy
T. +39 0543 448978
info@mondosofa.com



 Regione Emilia-Romagna



UNIONE EUROPEA
Fondo europeo di sviluppo regionale

Titolo intervento

Progetto di promozione dell'export attraverso la partecipazione all'evento fieristico internazionale ESPRITMEUBLE 2022.

Bando per progetti di promozione dell'export e per la partecipazione a eventi fieristici 2022

Intervento finanziato con risorse POR FESR 2014-2020

